

STATEMENT OF LINE

Frames

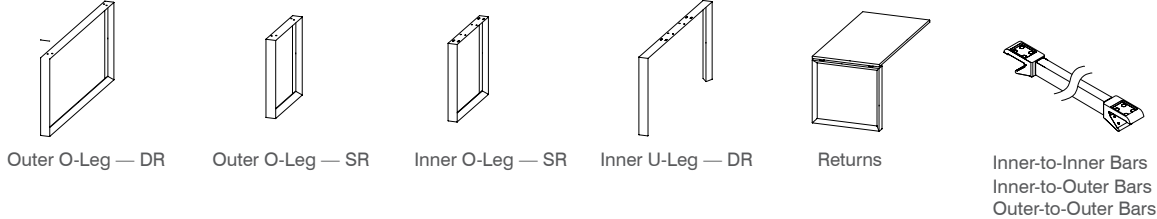

Worksurfaces

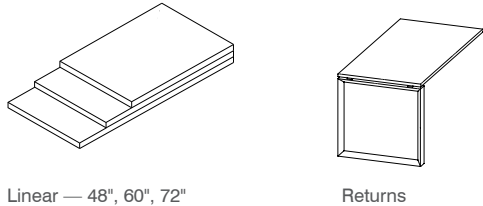

Privacy Screens & Panels

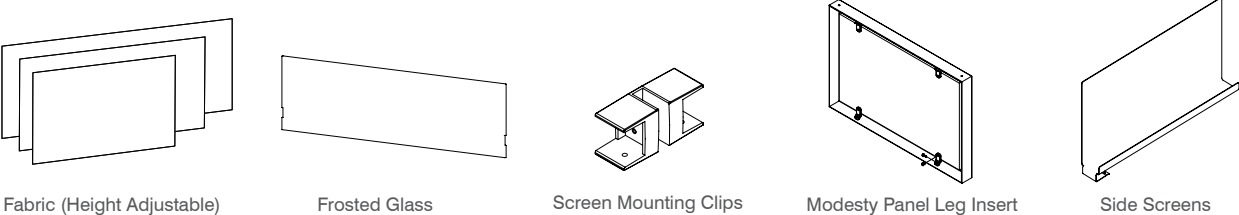

Accessories

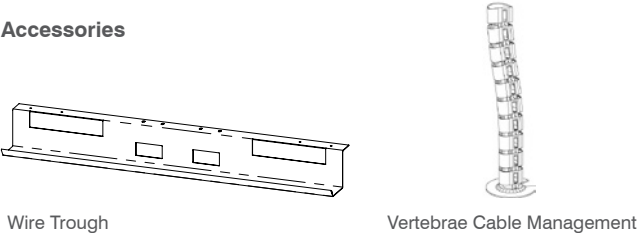

FINISHES

Worksurface

- 5 Day
 - Maple
 - Milk White
 - Teak
 - Walnut
- 10 Day
 - Acacia
 - Arctic White
 - Ash Wenge
 - Clay Wenge
 - Graphite Walnut
 - Seagull

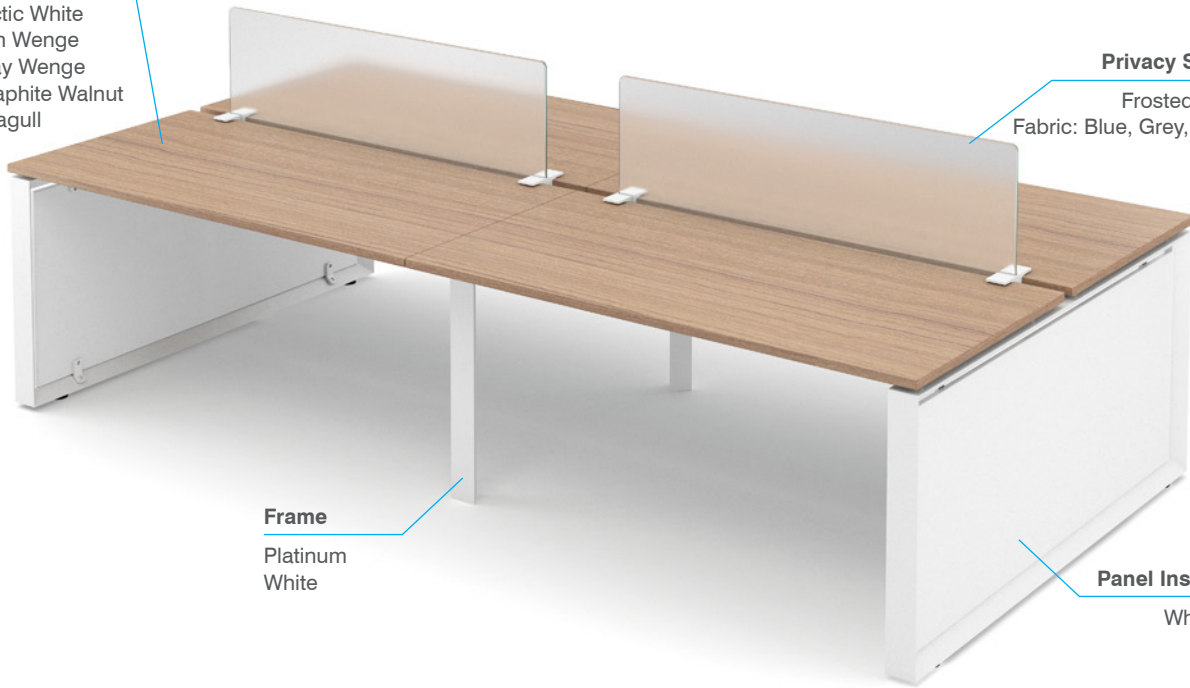

Privacy Screen

Frosted Glass
Fabric: Blue, Grey, Green

Frame

Platinum
White

Panel Insert

White

Worksurfaces



Milk White
W2.1



Maple
W2.2



Teak
W2.3



Walnut
W2.4



Arctic White
W2.5



Seagull
W2.6



Ash Wenge
W2.7



Clay Wenge
W2.8



Acacia
W2.9



Graphite Walnut
W2.10

Frames



Platinum
F1



White
F2

Fabric Screens

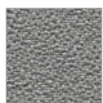

Nickel Grey



Aloe Green

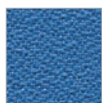

Varsity Blue

Frosted Glass Screen



Panel Insert



White

FEATURES



Height adjustable fabric screens



Frosted glass screens



Diamond legs with floating tops



Optional leg inserts



Magnetic Side screens



Above or below surface power

ELECTRICAL

ICON is designed for one Power Block and two Receptacles per user.
Electrical jumpers are snapped into power blocks in a daisy chain fashion.
Wire troughs manage wires (specify 1 per user).

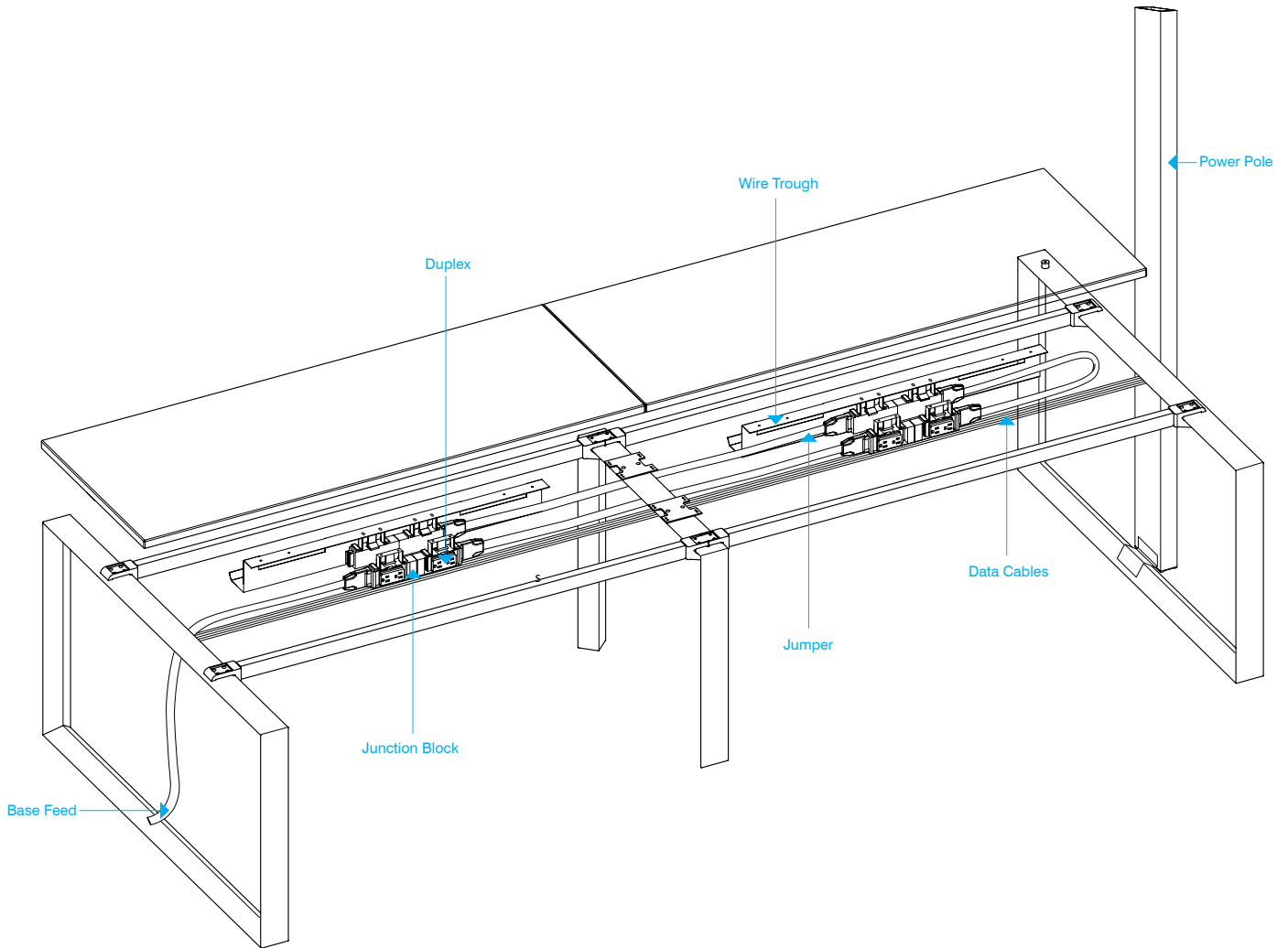

ELECTRICAL

3 Circuit/5 Wire Specification

Single Run (SR)

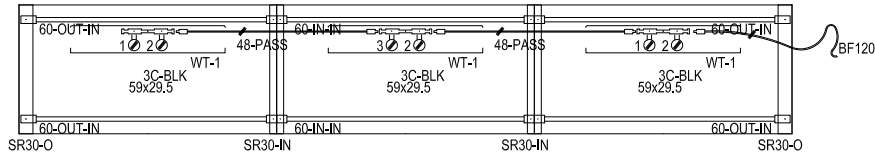

Double Run (DR)

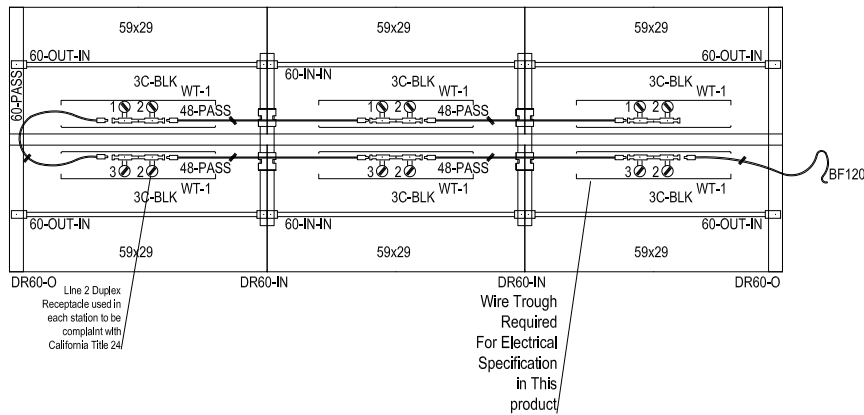

4 Circuit/8 Wire Specification

Single Run (SR)

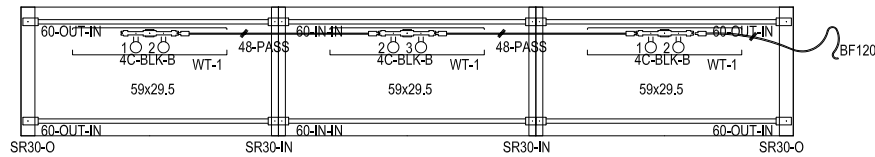

Double Run (DR)

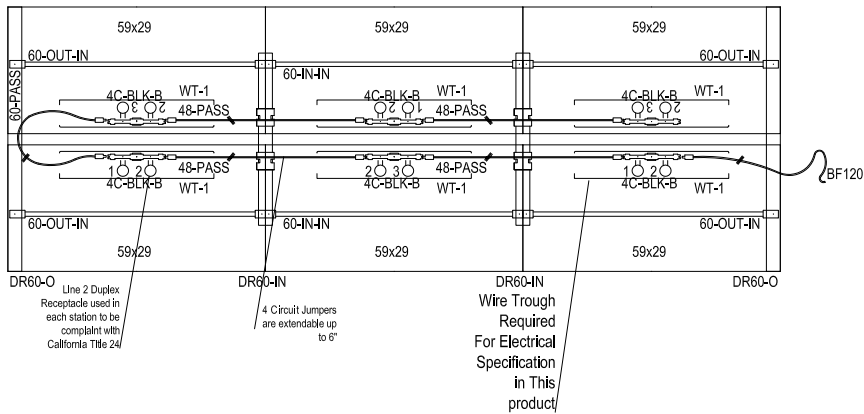

TYPICALS



60" x 30" Single Run 2 pack



60" x 30" Double Run 4 pack



60" x 30" Single Run 3 pack



60" x 30" Double Run 6 pack



60" x 30" Single Run 4 pack



60" x 30" Double Run 8 pack

INSTALLATION TIME

60 minutes per seat.

CARE & MAINTENANCE INSTRUCTIONS

Wipe with a damp cloth using water or gentle, unabrasive cleaner. For guaranteed safety, patch test with diluted cleaner before wiping entire surface. Wipe dry with a clean cloth.

WARRANTY

10 years, parts only. AMQ warrants that its products are free from defects in materials and workmanship for the life of the product. This warranty applies to ICON Products delivered in North America: United States, Canada and Mexico. The warranty is valid from the date of delivery, regardless of shift usage, to the original End User and is non-transferable.

CERTIFICATIONS

ANSI/BIFMA X5.5-2014
Indoor Advantage Gold

